

SHARPY WASH 330

ENGLISH





Katy Perry



**A LITTLE
WASHLIGHT
THAT MAKES A**

BIG

DIFFERENCE

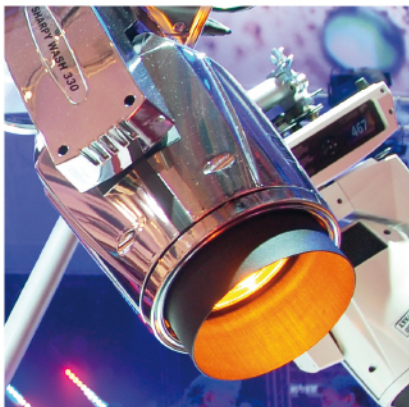

Romeo&Juliet



Mannheim

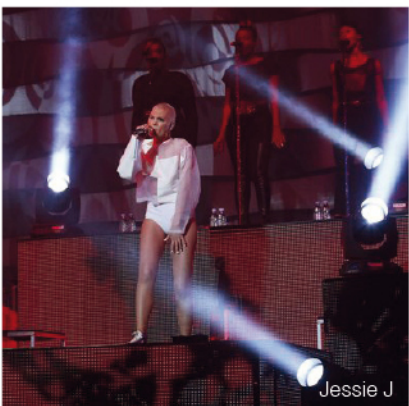



SHARPY WASH 330

When Clay Paky began the Sharpy Wash project, the instructions it gave its R&D department were very precise: design a small washlight with a discharge lamp that provides as much light as the most powerful washlights, but at the same time allows significant savings in energy and operating costs; all this without sacrificing technical performance in comparison with the most professional lights.

The result is there for everyone to see: the Sharpy Wash 330 is a remarkably compact lightweight washlight. Although its lamp is only 330 watts, it has the luminous efficiency and optical performance typical of lights in the 1000/1200 watt category.

A LIGHT BEAM SUITABLE FOR THE MOST SOPHISTICATED APPLICATIONS

The Sharpy Wash is equipped with a new 330 W lamp, which stands out for its brightness. It has a color temperature of 8000 K and rated life of 1500 hours.

A superior performance optical unit has been built around this lamp. It is highly versatile thanks to a zoom that ranges from 6.9° to 48°. The maximum beam angle makes the Sharpy Wash very interesting for theatres and television studios, where its light weight and small size also make it useful. The

minimum beam angle (6.9°) is so tight that it produces a beam very similar to that of a beam light so that lighting designers may use the light in very different ways.

Two frost filters are used to define the beam angle range. The "heavy" filter improves the uniformity of the illumination; the "light" filter softens the edges of the beam.

A rotating beam shaper may be used to ovalize the light and adapt the beam to the set designer's needs.

The Sharpy Wash 330 even has a motorized top hat, which is synchronized with the zoom lenses and eliminates all spilling lights. This device is usually only found on the most sophisticated and expensive washlights and is covered by a Clay Paky patent.

The dimmer is partly mechanical and partly electronic for highly accurate gradual attenuation of light intensity. There are several dimming curves, which may be selected from the light menu.



The top hat is a valuable feature especially in professional use, where any parasite emission must be eliminated.

Sharpy Wash 330 has a motorized top hat following the zoom excursion (Clay Paky patent).

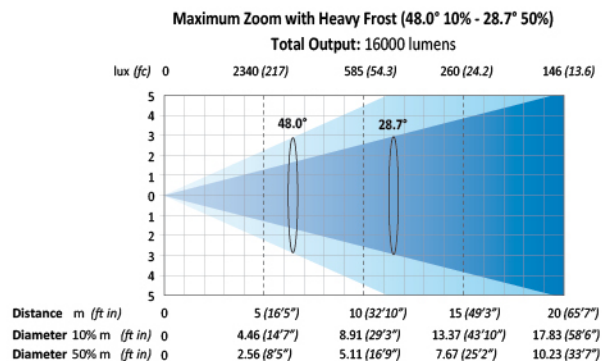
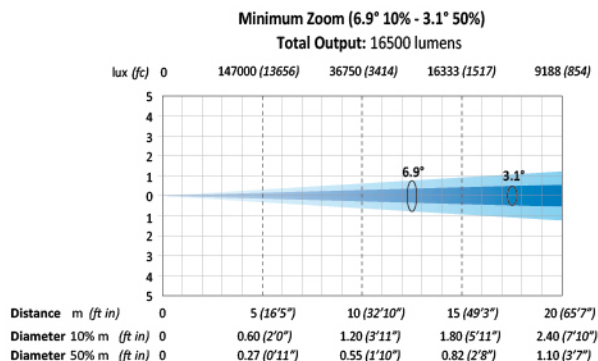

ECO-FRIENDLY AND ERGONOMIC LIKE FEW OTHERS

The Sharpy Wash 330 lamp has high luminous efficiency, which the special optical unit designed by Clay Paky exploits without dissipation. For this reason, the Sharpy Wash is as bright as an old generation washlight with a 1000/1200 watt lamp. This means energy savings, which lighting designers may take advantage of to reduce show operating costs or add extra lights without increasing power requirements. However, the features that make the Sharpy Wash eco-friendly do not end here.

The light is very lightweight and highly

compact. It weighs only 19 kg - half the weight of an equivalent 1200 W washlight - and it takes up only one third of the space. This obviously makes it easier to handle and simpler to install but - more importantly - it means huge savings in transport and inventory costs. It is not hard to understand why the Sharpy Wash has become the favourite light of riggers and rental companies.

The lamp life is longer than that of previous generation lamps, with further savings in operating costs, which are by no means negligible.

THE WAY YOU WANT IT, IN ORDER TO ENHANCE YOUR SET

The Sharpy Wash 330 comes in four colors: black (standard), white, gold and chrome. With these versions, the Sharpy Wash 330 opens up new horizons for interior designers, while complying fully with heat limitations. Dissipated heat usually damages chrome or gold-colored trims, but Clay Paky has designed, created and thoroughly tested special paints, which resist perfectly against deterioration over time, even in heavy duty use. The chrome version of Sharpy Wash 330 especially adapts to every set by becoming invisible to the eye and reflecting the ambient light.

Alternatively, it can enhance the surroundings and become a true piece of furniture on a set or TV studio stage, in showrooms, in conference rooms and during corporate events. The Sharpy Wash 330's ornamental features are patented to protect its look, which is entirely designed and manufactured in Italy.

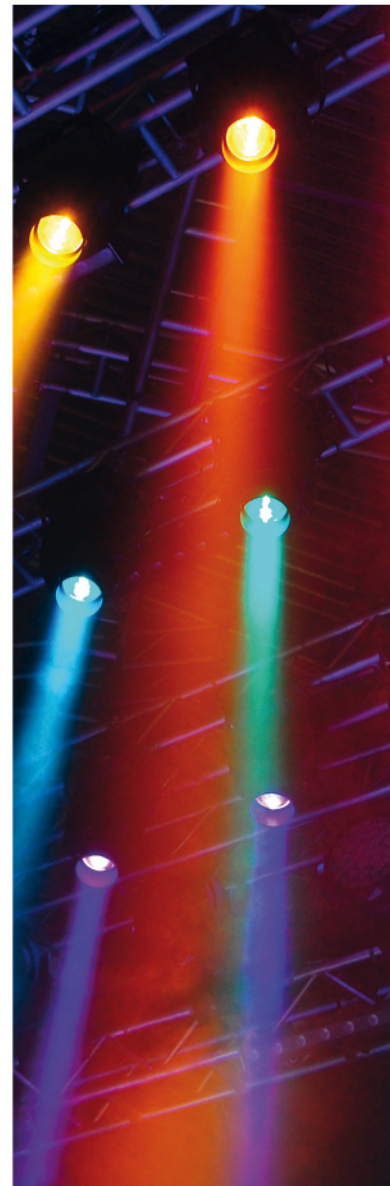

A QUALITY LIGHT WITH AN ENDLESS CHOICE OF COLORS

The Sharpy Wash 330 features a CMY color mixing system and a special color wheel able to create high quality colors.

The lamp color temperature is above 8000 K, but may be adjusted using three special colored filters: CTO 1, CTO 2 and half minus green.

The considerable advantage of using a discharge lamp is that it is easier to combine this washlight with lighting rigs that use other discharge lamps, which are extremely widespread in TV studios and large shows.

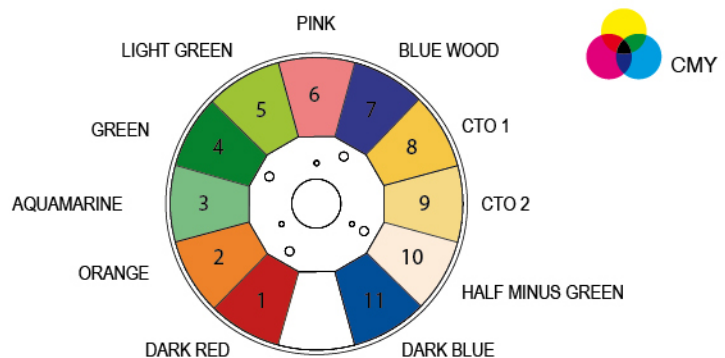

2014 NEW MODEL

SHARPY WASH 330 PC A SPECIAL LENS FOR A SPECIAL VERSION

The Sharpy Wash 330 PC, with plano-convex lens, was created for those who want a uniform wash light, but at the same time prefer a more penetrating light with more pronounced edges. From the effects point of view, the Sharpy Wash PC is identical to the standard version: full CMY color mixing, special colors, mechanical dimmer, a rotating beam shaper, two frost shades and a motorized top hat.

However, with the PC lens, the zoom only varies from 7° to 43°. This is a slightly narrower range, but with a higher light output, especially at wide angles.

A special lens kit to convert Sharpy Wash 330 into Sharpy Wash 330 PC is available (code C61465).



Minimum Zoom (7.2° 10% - 3.9° 50%)
Total Output: 18200 lumens

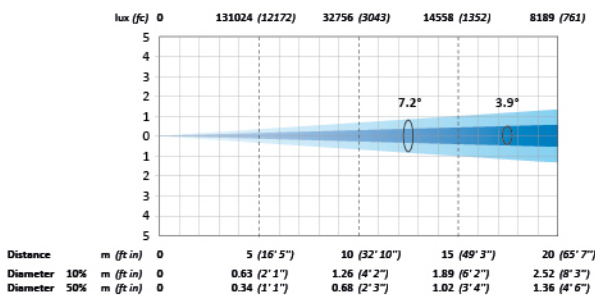

Maximum Zoom with Heavy Frost (42.9° 10% - 25.2° 50%)
Total Output: 15700 lumens

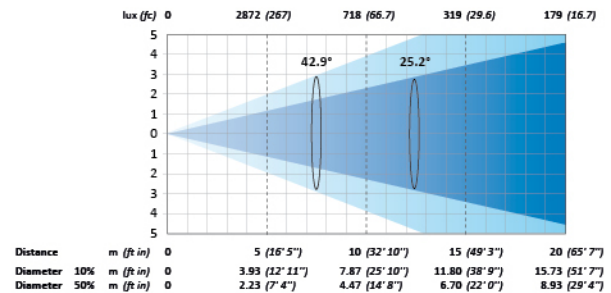

A CONVENTIONAL WASHLIGHT WITH VERY SPECIAL OOMPH

Nowadays lights abound on every stage, but the Sharpy Wash is a very different washlight, which stands out and remains impressed in your mind. The Sharpy Wash is an obedient working tool, which responds promptly to the basic needs of all lighting designers. However, when required, its unique exuberant personality comes to the fore.

At minimum beam angle, the Sharpy

Wash produces a beam like its brother "Sharpy". The color temperature is identical, and the same goes for the color range. In short, the two lights are designed to work perfectly together.

Even the movement speed and effects are the same as found on the fast Sharpy Beam. This is not only useful for dynamic sets, but also in wash mode when changing position in more conventional lighting designs.

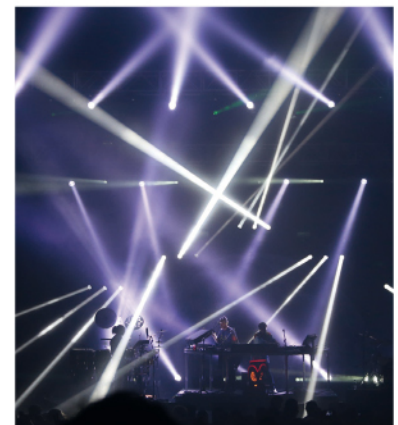

ACCESSORIES

PHILIPS MSD PLATINUM 16R LAMP (8000 K)	code LAM00E
OMEGA (2 pieces) - standard <i>Clamp fastening bracket</i>	code 183102/805
CLAMPS - optional <i>48-51 mm diameter truss hooks (300 kg max.)</i>	code C21070
FOAM SHELL - optional	code F21228
LENS CONVERSION KIT into Sharpy Wash 330 PC	code C61465

WEIGHT AND DIMENSIONS (mm/inches)

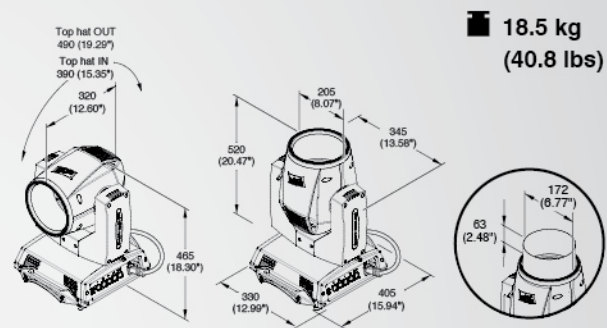

IGLOO



IGLOO
Outdoor cover (optional)
with Wireless DMX receiver/transmitter
code C61195

IGLOO EASY
Outdoor cover (optional)
Easy version with no W-DMX
code C61198

ROXTER-CASE



Roxter-case (+4 foam shells)
for 4 Sharpy Wash 330
code F21245

POWER SUPPLIES

115/230 V 50/60 Hz.

POWER CONSUMPTION

520 VA at 230 V 50 Hz.

LIGHT SOURCE AND OPTICS

Short-arc discharge lamp in a reflector.

- Lamp power: 330 W
- Color temperature: 8,000 K
- Luminous flux: 15,000 lm
- Average life: 1,500 hours

Optical unit: front Fresnel lens (patented spiral lens).

Zoom: from 6.9° to 48°.

CONTROL AND PROGRAMMING

22 DMX 512 channels (max.).

Signal protocol: USITT DMX 512.

Display: backlit black-and-white graphic LCD display

Pan/tilt resolution: 16 bit.

Movement control: vector.

DMX signal connection: 3 and 5 pin XLR input and output.

Software installation through DMX input.

HOUSING

Aluminium frame with die-cast plastic covers.

Two side handles for transport.

Pan and tilt lock mechanism for transport and maintenance.

MOVING HEAD

Range: 540° pan; 240° tilt.

Resolution: 2.11° pan; 0.008 pan fine; 0.98° tilt; 0.0004° tilt fine.

ELECTRONICS

Long-life auto-charging buffer battery.

Preset macros.

Function reset from control desk.

Lamp on/off controllable from remote control desk.

Menu-driven internal self-test function.

Ethernet ready.

Electronic check-up of every single parameter with error alarm.

Cooling system monitoring with automatic cut-out.

DMX level monitoring on each channel.

Automatic internal data transmission error diagnostics.

Firmware upgrade even when the unit is not connected to the power supply. Firmware transfer from one light to another.

WORKING POSITION

Any position. Anchoring system with rapid omega shackles (1/4 turn) on the base.

CE MARKING

Compliant with European Directives:

- 2006/95/CE - Electrical Safety: Low Voltage Directive (LVD).

- 2004/108/EC - Electromagnetic Compatibility Directive (EMC).

- 2011/65/EU - Restriction of Hazardous Substances Directive (RoHS).

ETL

This light is available with the cETLus mark, since it complies with the UL 1573 and CSA C22.2 No. 166 standards.

SHARPY WASH 330

WASHING THE WORLD WITH COLORS



AN OSRAM BUSINESS

CLAY PAKY S.p.A.
I - 24068 Seriate (BG) - Via Pastrengo, 3/b
Phone +39 035 654311 - Fax +39 035 301876
www.claypaky.it - info@claypaky.it



UNI EN ISO 9001