



www.claypaky.it

ENGLISH



SHARPY

Record-breaking speed, power and performance







SHARPY

code C61375



“EFFICIENT AND GREEN”
Natasha Katz, Lighting Designer



CE    IP20 $t_c 100^\circ\text{C}$ $t_a 40^\circ\text{C}$ 189W $\text{C} \dots 12 \dots \text{m}$ 

Sharpy is a 189W moving beam light with an unprecedented brightness usually achievable only with lamps of far greater wattages. It delivers a perfectly parallel, laser-like beam with an incredible output of almost 60,000 lx at 20m.

Sharpy is also groundbreaking for the purity of its beam, which is sharply defined and free of any halo or discoloration around the edges. It offers 14 different colors and 17 gobos, enabling a myriad of variable mid-air effects.

Sharpy's modest footprint (50cm, 19kg) makes it small enough to be fitted anywhere, on trusses at live and TV events, on stage, in showrooms or conference rooms.

RECORD-BREAKING EFFICIENCIES FROM A RADICAL NEW OPTIC

Sharpy's secret lies in the combination of a brand new lamp and an innovative optical design. It uses the Philips MSD Platinum 5R lamp (8000 K), which has an integrated reflector and is characterized by an extremely small arc gap – just 1mm. Clay Paky has used the peaky distribution that this lamp produces to its advantage. The optical unit is made

with high-quality lenses, designed to direct all the light emitted and produce a massive, parallel beam.

The extremely narrow 3.8° beam angle can be reduced all the way down to zero degrees, forming a laser-like beam that remains parallel even at great distances.

Thanks to a patented optical design, the

unit produces a pure beam with brilliant colors, free of discoloration or halation around the edges; the high 8000K colour temperature adds to the perception of brilliance.

The optical lenses are motorized to allow precise focus control of the image. Sharpy is capable of projecting pristine images from distances of 6m to infinity.



MINIATURE BUT MASSIVE

Sharpy is the most powerful-per-watt moving light on the market. Weighing just 19 kg, with an output of 59,760 lx at 20m (5,552 fc at 65 ft), Sharpy is capable of outshining fixtures with wattages seven or eight times greater – while consuming just 189W itself!

Sharpy brings a distinctive new look that has made an instant impact on stages and TV studios around the world. The unit also has excellent eco credentials demonstrating how ingenuity can turn a modest 189W light source into an effective instrument for large productions.

■ 19 Kg (41.88lbs)

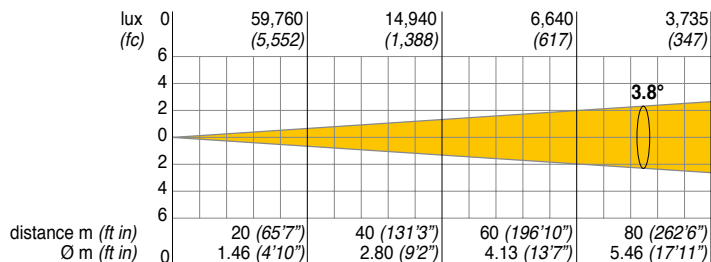
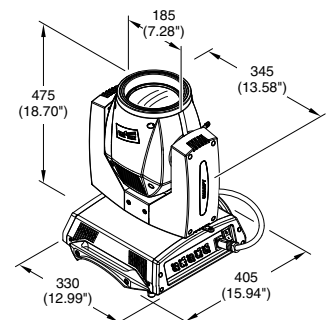

At 20m, the Sharpy projects a 1.46m-diameter beam with an illuminance of almost 60,000 lux at its widest aperture setting

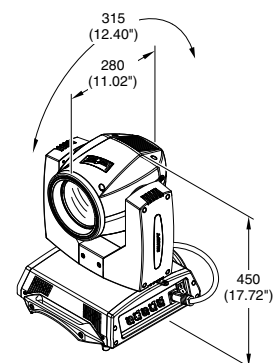

AERIAL EFFECTS OF ALL TYPES AND COLORS

Sharpy's spectacular mid-air effects are the result of a miniaturized system that includes 17 gobos, a rotating prism, a wheel with 14 colors, a dimmer, a linear frost and a strobe shutter.

The gobos are fixed in a wheel that is easily replaceable and includes 6 variably sized circular apertures, which reduce the beam angle from 3.8 to 0 degrees. The other gobos provide de-

signs that shape the beam for mid-air effects.

The rotating prism has 8 facets, which separate the light into 8 distinct beams, recalling a classic moonflower effect.

The motorized prism is able to shift along the optical axis, an ingenious piece of engineering that creates a zoom effect allowing the 8 beams to open and close like the petals of a flower.

Using the focus, it's possible to achieve an interesting new effect. The Sharpy's beam has an external crossover point where the beam appears to converge before spreading out again. By carefully adjusting the focus control, you can visibly move that crossover point back and forth along the beam to create a totally new effect. The effect is most clearly visible when used with haze.



Zero-degree white beam

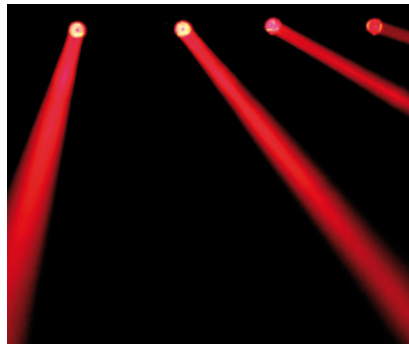

Pure-red parallel beam



Rotating prism

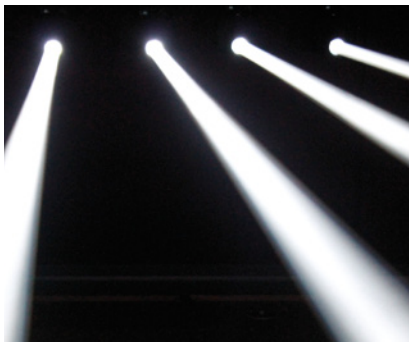

Zoomed white beam



Frosted beam



Split colors + prism

AS FAST AS A MOVING MIRROR FIXTURE...

Sharpy's rapid PAN/TILT movements display the sort of speed and snappy acceleration normally associated with moving mirror fixtures. Movements are meticulously precise and repeatable in addition to being fast. Agility and precision of movement are enhanced by its small size and powerful electronics.

540° PAN	252° TILT	Gobo change	Prism insertion	Color change	0-100% focus
2.4 sec	1.3 sec	0.095 sec (100 rpm)	0.357 sec (43 rpm)	0.127 sec (160 rpm)	1.111 sec

NOT JUST FOR EFFECTS

Sharpy's attractive beam is bound to make it a popular effect light, yet its use goes far beyond the production of super-concentrated beams. Sharpy doubles as a professional spotlight, capable of projecting pristine, sharp images, better than other beam lights on the market, particularly over long distances. Surface projections can be enhanced with the use of the rotating prism, while gobo transitions occur instantaneously.

Sharpy can also be used as a professional wash light alongside other units on the rig. Its frost system produces a soft, evenly colored beam. The projector offers a total of 14 dichroic colors, on a single, replaceable wheel. The colors - even the most saturated - are particularly bright, thanks to the intensity of the lamp, and are able to create uniform color washes at great distances. On the wheel are also two shades of CTO and

a CTB filter. Movement from one adjacent color to the next is instantaneous at about 0.1 sec, while the maximum wheel spin speed (160 rpm) allows an impressive pulsating rainbow effect. Rotation is bi-directional, smooth and adjustable in speed from 0.2 to 160 rpm. Both single and split color beams are possible.

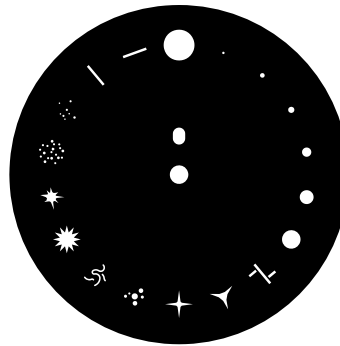
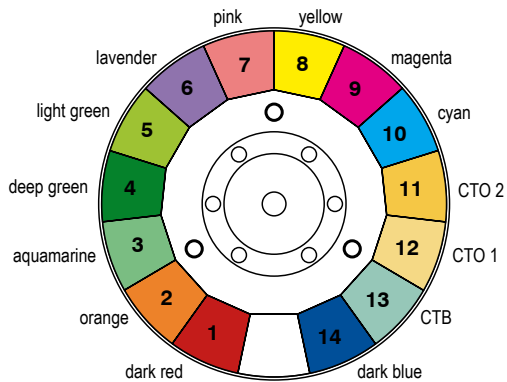

A masterpiece of mechanical miniaturization

Although the colors and gobos are not individually replaceable, each of the standard metal wheels can be replaced with new wheels containing special colors and gobos. A magnetic attachment system allows the wheels to be changed quickly and without the use of tools.

EASY TO HANDLE

Lighting designers quickly appreciated the creative possibilities that the Sharpy has to offer. But Sharpy goes way beyond. At just 19 kg, the unit is not only easily transportable but also easily managed by a lone technician. Its light weight translates to less stress up in the rig, too. Moreover, its small size occupies less space in trucks and in storage, which in turn means more savings on the overall production.

Installers and roadies will love the unit's portability, while technicians and operators will enjoy the product's simplicity of use.

And what about savings in electricity? Sharpy's massive stadium-filling presence comes at a cost of just 189 W and 350 VA per luminaire. And, with an average lamp life of 2000 hours, the unit will please both technicians and accountants alike.





NOW AVAILABLE IN WHITE, SILVER OR GOLD.

The Sharpy is also available in white, silver and gold metallic finishes. The decorative finishes expand the range of options for the Sharpy, and are ideal for applications where the fixture has to remain in view: such as in TV studios, showrooms, fairs, conferences or at industrial presentations.

Besides adding a flash of glamour, the reflective Sharpys blend comfortably into their surroundings and are less distracting to the eye. Each finish is carefully designed to preserve the fixture's thermal qualities without tarnishing or deteriorating in any way.



ACCESSORIES

Igloo Code C61195

Igloo is a fully outdoor enclosure that allows Sharpy to operate in the most severe weather conditions. It comes with onboard wireless DMX receiver, and a unique system that automatically maintains internal temperature above 0°C and below 35°C (32°F - 95°F).

Heat screen Code C61190

In TV studios and other tight spaces, sometimes Sharpy's concentrated, long-throw beam may be more than is called for. For such situations we have designed a special heat filter accessory, that when installed in the luminaire reduces the minimum distance at which objects can be illuminated from 12 to 8 metres, with a reduction of 30% in light output.



Foam Shell Code F21178

Flight case for 4 projectors (including 4 foam shells) Code F21200

The special Sharpy Raxter- case with room for 4 fixtures is part of a dedicated series of flight cases built to ATA standards for commercial shipping. Made from the toughest, high-tech materials, the flight case protects against impacts and weather and ensures safe and easy handling.

TECHNICAL FEATURES

- Light source: Philips MSD Platinum 5R (8000K, 2000 hrs)
- Power supply: 115-230 V; 50/60 Hz
- Power consumption: 350VA at 230V, 50 Hz
- Optics: 3-lens HQ optical group (patent pending); Zoom: from zero to 3.8°;
Focus: electronic; Light output at 20m (65 ft): 59,760 lx (5552 fc)
- Replaceable color wheel with 14 fixed colors + open
- Effects: Replaceable gobo wheel with 17 fixed gobos + open; High speed shake effect; 8-facet rotating prism;
- Linear Frost filter; Mechanical shutter and adjustable speed strobe effect;
Mechanical dimmer
- Control channels: 20
- Long-lasting, self-charging back-up battery
- Ethernet ready
- Update firmware without having to power the projector
- Transfer firmware from one projector to another

SHARPY HITS THE ROAD RUNNING



2012 London Olympic Games

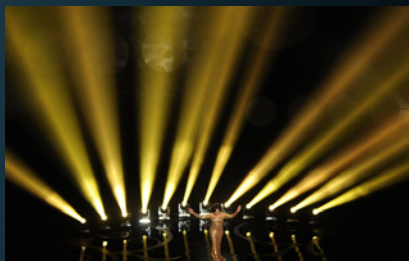

The 85th Academy Awards



Eurovision Song Contest, Azerbaijan

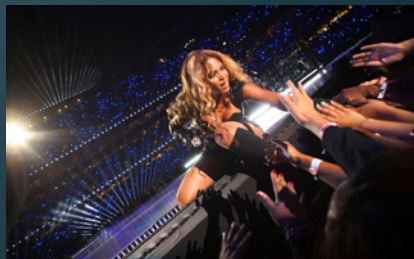

Beyoncé, Super Bowl XLVII Halftime Show



Madonna, Super Bowl XLVI Halftime Show



Queen's Diamond Jubilee, UK



Rolling Stones, 50th Anniversary Tour



Paul McCartney World Tour



The Who, US Tour

REVIEWS

This is the type of output normally seen with Xenon fixtures, not sub-200W lamps that could pass as carry-on luggage.

Patrick Dierson, Live Design Online, February 2011

Clay Paky in their turn have done a good job of optical design to provide as narrow a beam as I've seen for some time.

Mike Wood, Lighting & Sound America, March 2011

Sharpy projects an extremely bright, sharp and narrow beam with less electricity, yet no compromise to the quality of the projection.

Douglas Cole, Sound & Lite, March/April 2011

I have to admit this fixture is the closest I have ever seen a yoke light move to a mirrored fixture. [...] It is indeed the new age equivalent of a par 46 ACL beam on steroids.

Nook Schoenfeld, PLSN, June 2011

Sharpy is a miniature Beam Light providing extreme power without compromises. Its production and engineering quality is of the highest level and its optical quality sets a new benchmark.

Production Partner, March 2011

What was really impressive... the speed of the fixture. The Sharpy is SUPER fast with it's pan and tilt. It's so fast it almost hurts to watch the fixture move.

Justin Lang, iSquint.net, March 2011

QUOTES

The light output from such a small package is amazing. The fast speed of movement was breathtaking. The lamps were small and discreet enough not to draw the eye in the set, but the effect they produced was gigantic!

Lee Allen, Lighting Director for BBC

It's a new type of light; we haven't seen anything like it before. I must admit I have been completely enchanted by their speed.

Adam Tyszka, Lighting Director for TVP2

Don't be fooled by the Sharpy small package - I was lighting up buildings across the highway with these fixtures!

Steve Lieberman, lighting designer

Sharpy units are unbelievably fast. They have a 'mirror-like' speed combined with the organic elements of a moving head.

Rohan Thornton, lighting designer

The Sharpy definitely provided the bang for the buck. We used to be amazed when the Alpha 300 first came out; and now here's the Sharpy putting out much more light using just half the power - it's ridiculously bright.

Tim Routledge, lighting designer

They deliver all those beam effects and everything you need to get that extra layer that really punches through.

Eric Wade, lighting designer and programmer

We never thought we'd see a 190W light that we could use in Wembley Arena.

Plasa Awards judges

This is the beginning of more lights that have to be like this. Efficient and green.

Natasha Katz, LD and member of the Plasa "Rock Our World Awards" jury

Absolutely brilliant - an amazing amount of light coming out of such a small piece of kit.

Nick Jones, member of the Plasa "Rock Our World Awards" jury

SEE SHARPY ON:



www.youtube.com/watch?v=wcwxPytxm10



CLAY PAKY S.p.A.
I - 24068 Seriate (BG) - Via Pastrengo, 3/b
Phone +39 035 654311 - Fax +39 035 301876
www.claypaky.it - cp.info@claypaky.it



UNI EN ISO 9001